



ON Semiconductor®

BS170 / MMBF170 N-Channel Enhancement Mode Field Effect Transistor

General Description

These N-Channel enhancement mode field effect transistors are produced using ON Semiconductor's proprietary, high cell density, DMOS technology. These products have been designed to minimize on-state resistance while provide rugged, reliable, and fast switching performance. They can be used in most applications requiring up to 500mA DC. These products are particularly suited for low voltage, low current applications such as small servo motor control, power MOSFET gate drivers, and other switching applications.

Features

- High density cell design for low $R_{DS(ON)}$.
- Voltage controlled small signal switch.
- Rugged and reliable.
- High saturation current capability.

BS170

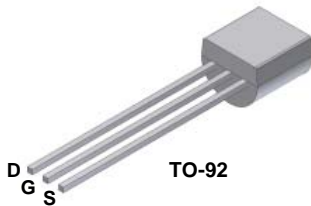

MMBF170

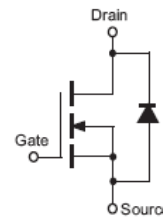
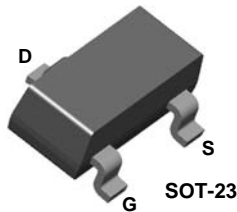

Absolute Maximum Ratings $T_A = 25^\circ\text{C}$ unless otherwise noted

Symbol	Parameter	BS170	MMBF170	Units
V_{DSS}	Drain-Source Voltage	60		V
V_{DGR}	Drain-Gate Voltage ($R_{GS} \leq 1M\Omega$)	60		V
V_{GSS}	Gate-Source Voltage	± 20		V
I_D	Drain Current - Continuous - Pulsed	500	500	mA
		1200	800	
T_J, T_{STG}	Operating and Storage Temperature Range	- 55 to 150		$^\circ\text{C}$
T_L	Maximum Lead Temperature for Soldering Purposes, 1/16" from Case for 10 Seconds	300		$^\circ\text{C}$

Thermal Characteristics $T_A = 25^\circ\text{C}$ unless otherwise noted

Symbol	Parameter	BS170	MMBF170	Units
P_D	Maximum Power Dissipation Derate above 25°C	830	300	mW
		6.6	2.4	$\text{mW}/^\circ\text{C}$
$R_{\theta JA}$	Thermal Resistance, Junction to Ambient	150	417	$^\circ\text{C}/\text{W}$

Electrical Characteristics $T_A=25^\circ\text{C}$ unless otherwise noted

Symbol	Parameter	Conditions	Type	Min.	Typ.	Max.	Units
OFF CHARACTERISTICS							
BV_{DSS}	Drain-Source Breakdown Voltage	$V_{GS} = 0V, I_D = 100\mu A$	All	60			V
I_{DSS}	Zero Gate Voltage Drain Current	$V_{DS} = 25V, V_{GS} = 0V$	All			0.5	μA
I_{GSSF}	Gate - Body Leakage, Forward	$V_{GS} = 15V, V_{DS} = 0V$	All			10	nA
ON CHARACTERISTICS (Notes 1)							
$V_{GS(th)}$	Gate Threshold Voltage	$V_{DS} = V_{GS}, I_D = 1mA$	All	0.8	2.1	3	V
$R_{DS(on)}$	Static Drain-Source On-Resistance	$V_{GS} = 10V, I_D = 200mA$	All		1.2	5	Ω
g_{FS}	Forward Transconductance	$V_{DS} = 10V, I_D = 200mA$	BS170		320		mS
		$V_{DS} \geq 2 V_{DS(on)}, I_D = 200mA$	MMBF170		320		
Dynamic Characteristics							
C_{iss}	Input Capacitance	$V_{DS} = 10V, V_{GS} = 0V, f = 1.0MHz$	All		24	40	pF
C_{oss}	Output Capacitance		All		17	30	pF
C_{rss}	Reverse Transfer Capacitance		All		7	10	pF
Switching Characteristics (Notes 1)							
t_{on}	Turn-On Time	$V_{DD} = 25V, I_D = 200mA, V_{GS} = 10V, R_{GEN} = 25\Omega$	BS170			10	ns
		$V_{DD} = 25V, I_D = 500mA, V_{GS} = 10V, R_{GEN} = 50\Omega$	MMBF170			10	
t_{off}	Turn-Off Time	$V_{DD} = 25V, I_D = 200mA, V_{GS} = 10V, R_{GEN} = 25\Omega$	BS170			10	ns
		$V_{DD} = 25V, I_D = 500mA, V_{GS} = 10V, R_{GEN} = 50\Omega$	MMBF170			10	

Note:

1. Pulse Test: Pulse Width $\leq 300\mu s$, Duty Cycle $\leq 2.0\%$.

Ordering Information

Part Number	Package	Package Type	Lead Frame	Pin array
BS170	TO-92	BULK	STRAIGHT	D G S
BS170-D26Z	TO-92	Tape and Reel	FORMING	D G S
BS170-D27Z	TO-92	Tape and Reel	FORMING	D G S
BS170-D74Z	TO-92	AMMO	FORMING	D G S
BS170-D75Z	TO-92	AMMO	FORMING	D G S
MMBF170	SOT-23	Tape and Reel		

Typical Electrical Characteristics

BS170 / MMBF170

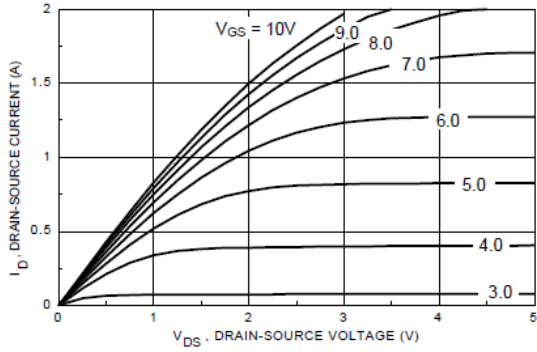

Figure 1. On-Region Characteristics.

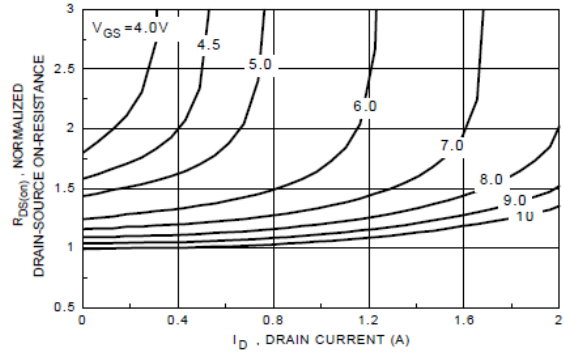

Figure 2. On-Resistance Variation with Gate Voltage and Drain Current.

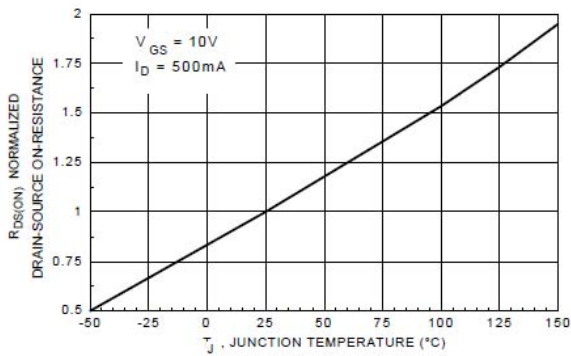

Figure 3. On-Resistance Variation with Temperature.

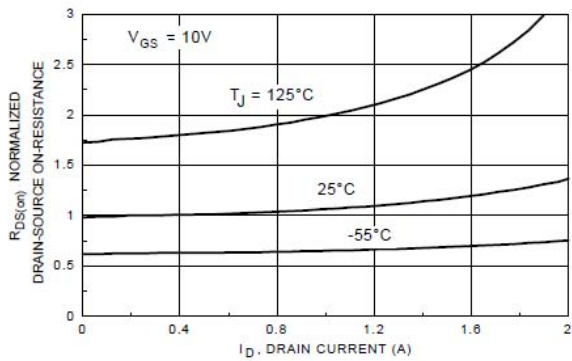

Figure 4. On-Resistance Variation with Drain Current and Temperature.

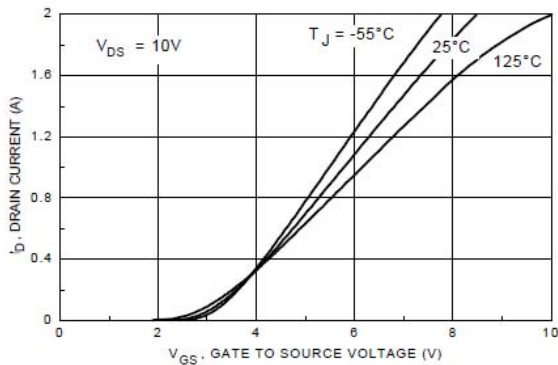

Figure 5. Transfer Characteristics.

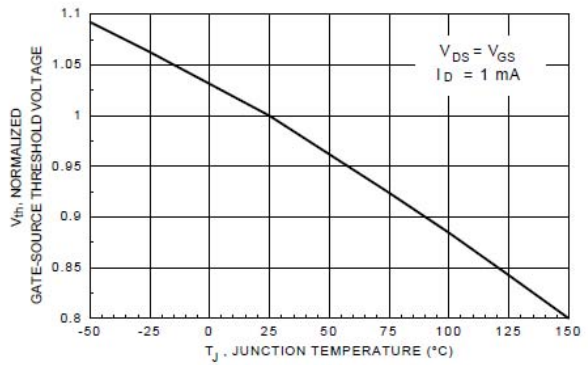

Figure 6. Gate Threshold Variation with Temperature.

Typical Electrical Characteristics (continued)

BS170 / MMBF170

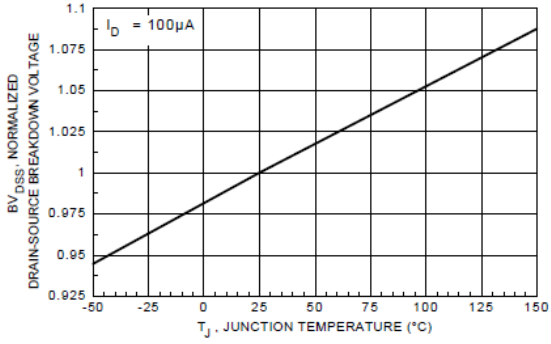

Figure 7. Breakdown Voltage Variation with Temperature.

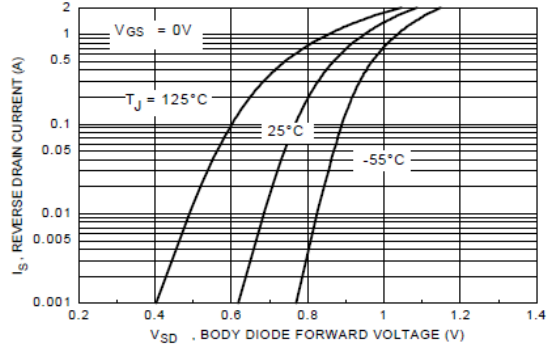

Figure 8. Body Diode Forward Voltage Variation with Current and Temperature.

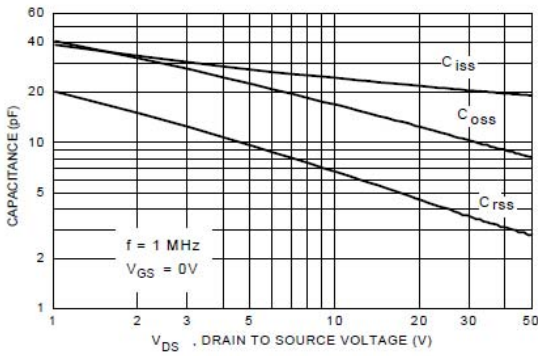

Figure 9. Capacitance Characteristics.

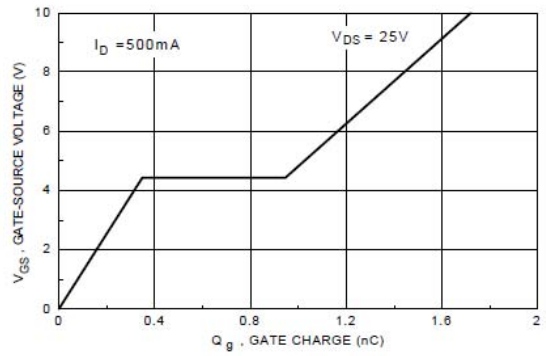

Figure 10. Gate Charge Characteristics.

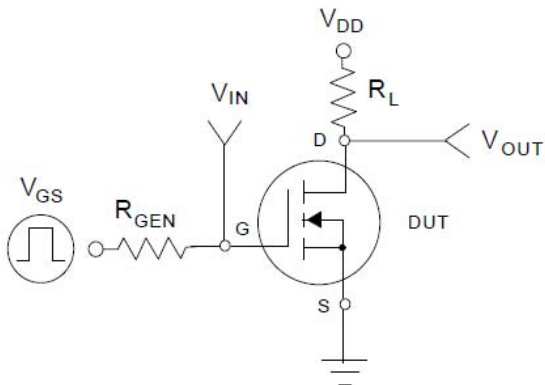

Figure 11. Switching Test Circuit.

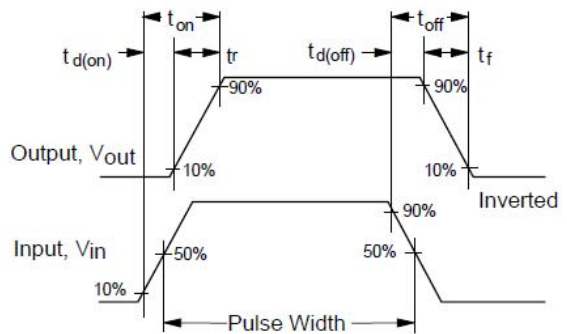

Figure 12. Switching Waveforms.

Typical Electrical Characteristics (continued)

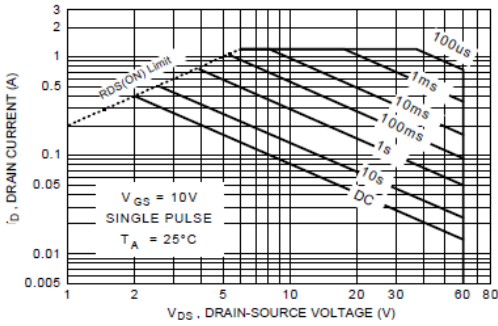

Figure 13. BS170 Maximum Safe Operating Area.

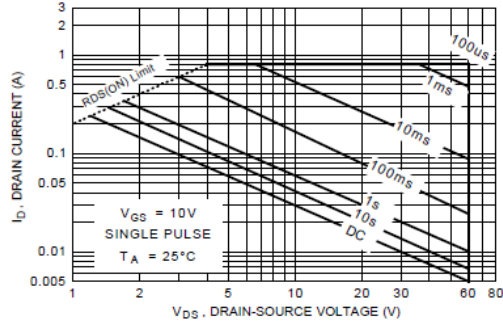

Figure 14. MMBF170 Maximum Safe Operating Area.

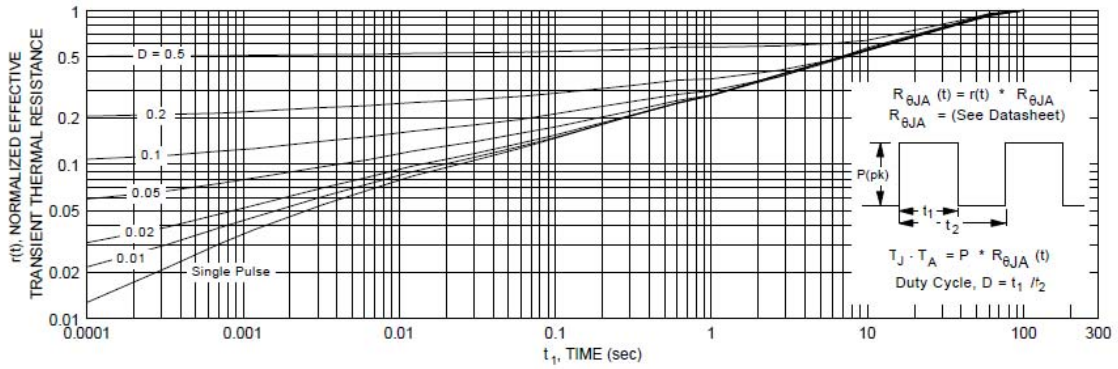

Figure 15. TO-92, BS170 Transient Thermal Response Curve.

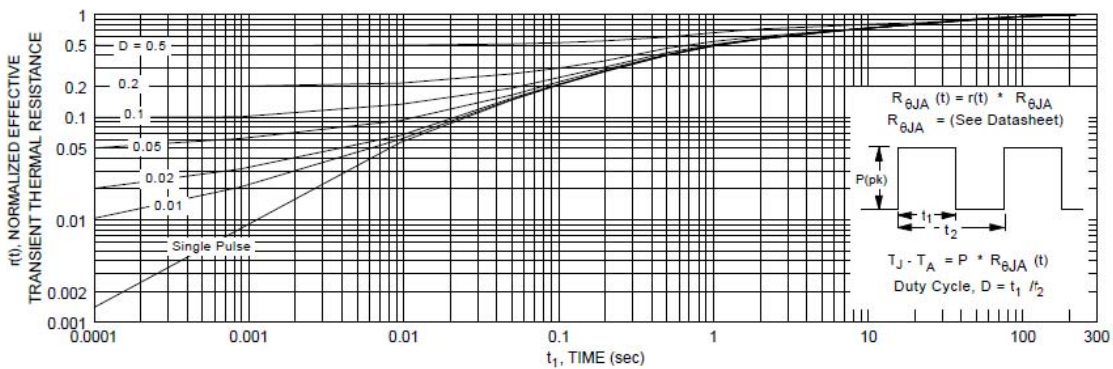
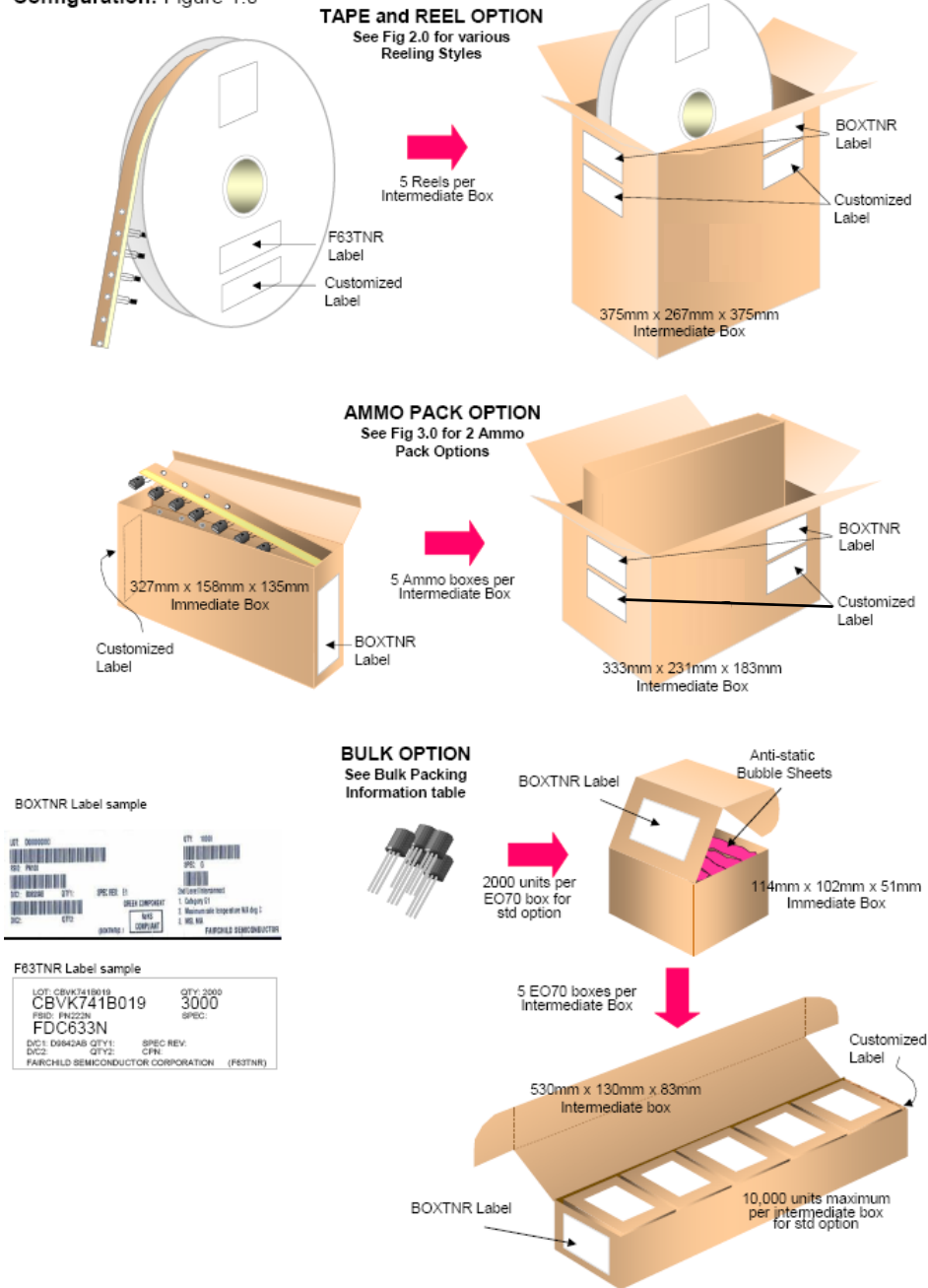

Figure 16. SOT-23, MMBF170 Transient Thermal Response Curve.

TO-92 Tape and Reel Data

TO-92 Packaging Configuration: Figure 1.0



TO-92 Tape and Reel Data, continued

TO-92 Packing





Information: Figure 2.0

TO-92 TNR/AMMO PACKING INFORMATION TABLE

Packing	Style	Quantity	EOL code
Reel	A	2,000	D26Z
	B	2,000	D11Z
	C	2,000	D28Z
	D	2,000	D10Z
	E	2,000	D27Z
	F	2,000	D81Z
	G	2,000	D29Z
	H	2,000	D89Z
Ammo	M	2,000	D74Z
	P	2,000	D75Z

Unit weight = 0.22 gm
 Reel weight with components = 1.04 kg
 Ammo weight with components = 1.02 kg
 Max quantity per intermediate box = 10,000 units

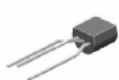
TO-92 BULK PACKING INFORMATION TABLE

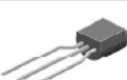
EOL CODE / FLOW OPTION	DESCRIPTION	LEADCLIP DIMENSION	MINIMUM ORDER QTY	LEADFORM OUTLINE
NO EOL CODE	STRAIGHT LEADS	NO LEAD CLIP	2.0K / BOX	
J18Z	TO-18 OPTION STD	NO LEAD CLIP	2.0K / BOX	
J35Z	TO-18 OPTION REVERSE	NO LEAD CLIP	2.0K / BOX	
J05Z	TO-5 OPTION STD	NO LEAD CLIP	1.5K / BOX	
J60Z	TO-5 OPTION REVERSE	NO LEAD CLIP	1.5K / BOX	
J61Z	IN LINE 0.200 SPACING	NO LEAD CLIP	1.5K / BOX	

TO-92 Tape and Reel Data, continued

TO-92 Reeling Style

Configuration: Figure 3.0

Machine Option "A" (H)

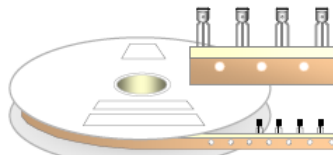

Style "A", D26Z

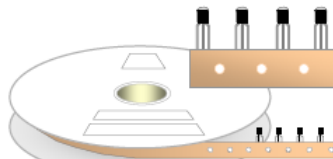

Style "B", D11Z

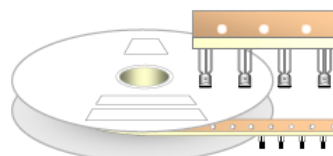

Style "C", D28Z

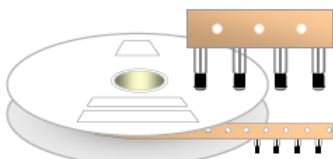

Style "D", D10Z

Machine Option "E" (J)

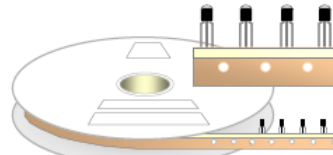

Style "E", D27Z

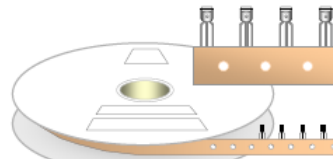

Style "F", D81Z

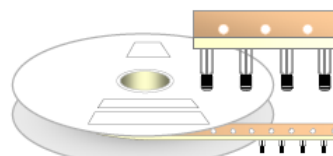

Style "G", D29Z

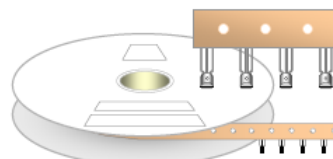

Style "H", D89Z

TO-92 Radial Ammo Packaging

Configuration: Figure 4.0

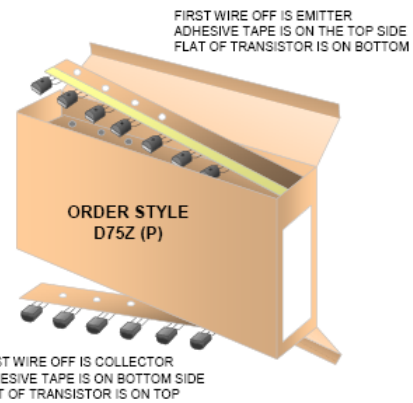
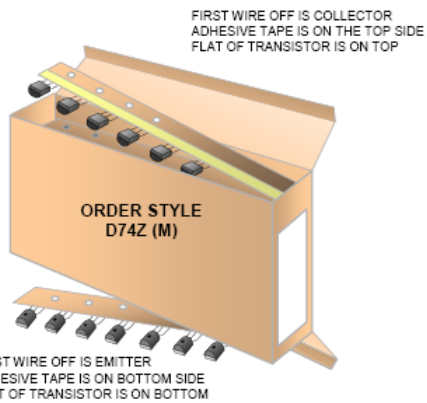

TO-92 Tape and Reel Data, continued

TO-92 Tape and Reel Taping Dimension Configuration: Figure 5.0

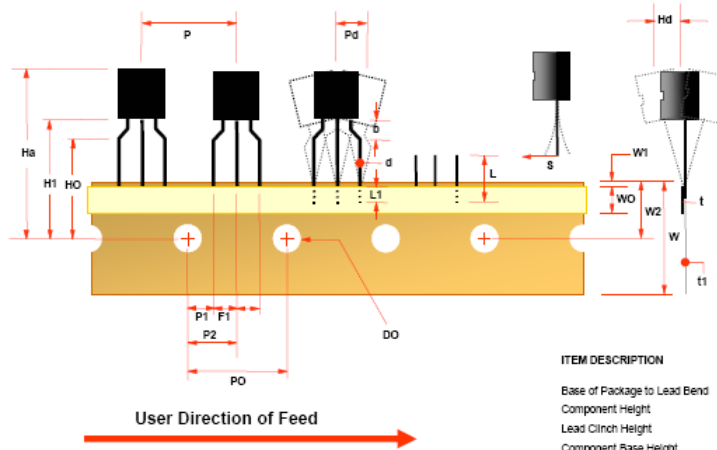

ITEM DESCRIPTION	SYMBOL	DIMENSION
Base of Package to Lead Bend	b	0.098 (max)
Component Height	Ha	0.929 (+/- 0.025)
Lead Clinch Height	HO	0.630 (+/- 0.020)
Component Base Height	H1	0.748 (+/- 0.020)
Component Alignment (side/side)	Pd	0.040 (max)
Component Alignment (front/back)	Hd	0.031 (max)
Component Pitch	P	0.500 (+/- 0.020)
Feed Hole Pitch	PO	0.500 (+/- 0.008)
Hole Center to First Lead	P1	0.150 (+0.009, -0.010)
Hole Center to Component Center	P2	0.247 (+/- 0.007)
Lead Spread	F1/F2	0.104 (+/- 0.010)
Lead Thickness	d	0.018 (+0.002, -0.003)
Cut Lead Length	L	0.429 (max)
Taped Lead Length	L1	0.209 (+0.051, -0.052)
Taped Lead Thickness	t	0.032 (+/- 0.006)
Carrier Tape Thickness	t1	0.021 (+/- 0.006)
Carrier Tape Width	W	0.708 (+0.020, -0.019)
Hold - down Tape Width	WO	0.236 (+/- 0.012)
Hold - down Tape position	W1	0.035 (max)
Feed Hole Position	W2	0.360 (+/- 0.025)
Sprocket Hole Diameter	DO	0.157 (+0.008, -0.007)
Lead Spring Out	S	0.004 (max)

TO-92 Reel Configuration: Figure 6.0

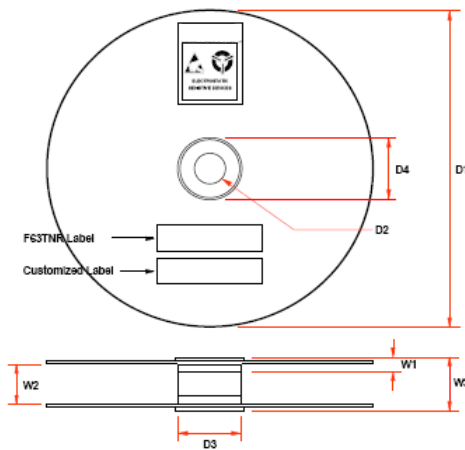

ITEM DESCRIPTION	SYMBOL	MINIMUM	MAXIMUM
Reel Diameter	D1	13.975	14.025
Arbor Hole Diameter (Standard)	D2	1.160	1.200
(Small Hole)	D2	0.650	0.700
Core Diameter	D3	3.100	3.300
Hub Recess Inner Diameter	D4	2.700	3.100
Hub Recess Depth	W1	0.370	0.570
Flange to Flange Inner Width	W2	1.630	1.690
Hub to Hub Center Width	W3		2.090

Note: All dimensions are in inches

Mechanical Dimensions (TO-92)

TO-92

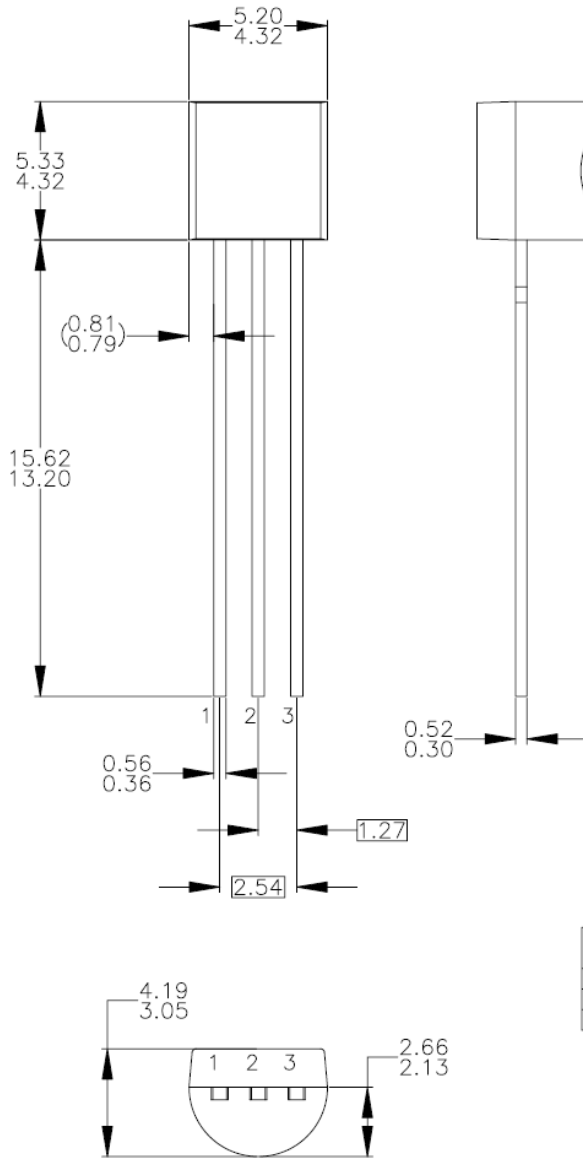

NOTES: UNLESS OTHERWISE SPECIFIED

- A) DRAWING WITH REFERENCE TO JEDEC TO-92 RECOMMENDATIONS.
- B) ALL DIMENSIONS ARE IN MILLIMETERS.
- C) DRAWING CONFORMS TO ASME Y14.5M-1994.
- D) TO-92 (92,94,96,97,98) PIN CONFIGURATION:

PIN	92			94			96			97			98		
	P	F	M	P	F	M	P	F	M	P	F	M	P	F	M
1	E	S	S	E	S	S	B	D	G	C	G	D	C	G	D
2	B	D	G	C	G	D	E	S	S	B	D	G	E	S	S
3	C	G	D	B	D	G	C	G	D	E	S	S	B	D	G

LEGEND:

- P - BIPOLAR
- F - JFET
- M - DMOS
- E - EMITTER
- B - BASE
- C - COLLECTOR
- D - DRAIN
- S - SOURCE
- G - GATE

- E) FOR PACKAGE 92, 94, 96, 97 AND 98: PIN CONFIGURATION DRAIN "D" AND SOURCE "S" ARE INTERCHANGEABLE AT JFET "F" OPTION.
- F) DRAWING FILENAME: MKT-2A03DREV3.

Dimensions in Millimeters

SOT-23 Std Tape and Reel Data

SOT23-3L Packaging Configuration: Figure 1.0

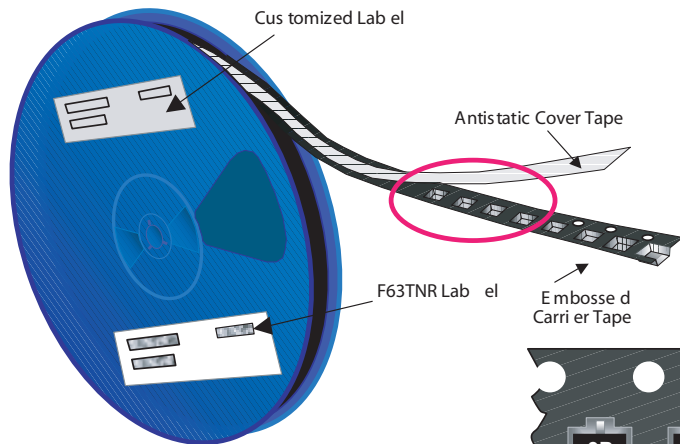

Packaging Description:

SOT23-3L parts are shipped in tape. The carrier tape is made from a dissipative (carbon filled) polycarbonate resin. The cover tape is a multilayer film (Heat Activated Adhesive in nature) primarily composed of polyester film, adhesive layer, sealant, and anti-static sprayed agent. These reeled parts in standard option are shipped with 3,000 units per 7" or 177mm diameter reel. The reels are dark blue in color and is made of polystyrene plastic (anti-static coated). Other option comes in 10,000 units per 13" or 330mm diameter reel. This and some other options are described in the Packaging Information table.

These full reels are individually labeled and placed inside a standard intermediate box made of recyclable corrugated brown paper with a ON Semiconductor logo printing. One box contains five reels maximum. And these intermediate boxes are placed inside a labeled shipping box which comes in different sizes depending on the number of parts shipped.

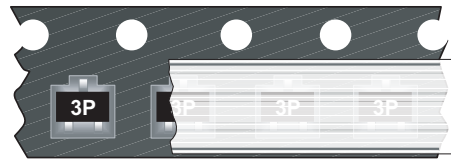

SOT23-3L Unit Orientation

SOT23-3L Packaging Information		
Packaging Option	Standard (no flow code)	D87Z
Packaging type	TNR	TNR
Qty per Reel/Tube/Bag	3,000	10,000
Reel Size	7" Dia	13"
Box Dimension (mm)	193x183x80	355x333x40
Max qty per Box	15,000	30,000
Weight per unit (gm)	0.0082	0.0082
Weight per Reel (kg)	0.1175	0.4006
Note/Comments		

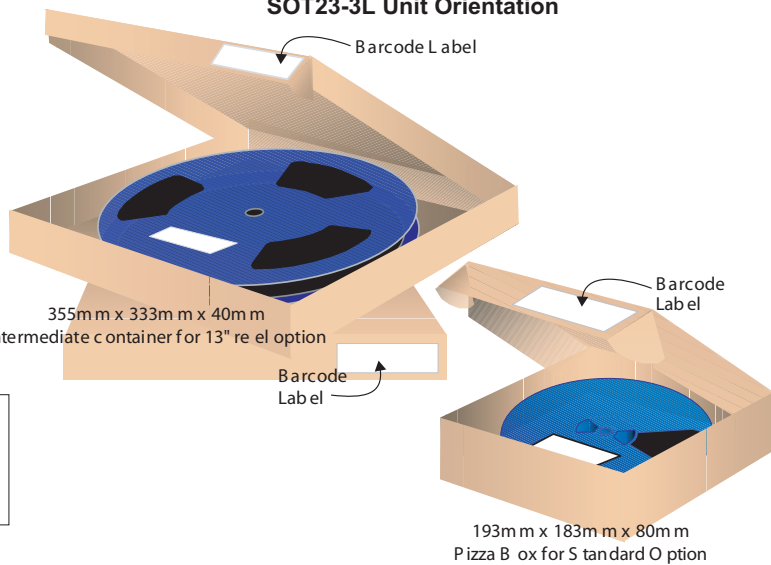

Barcode Labels Sample



SOT23-3L Tape Leader and Trailer Configuration: Figure 2.0

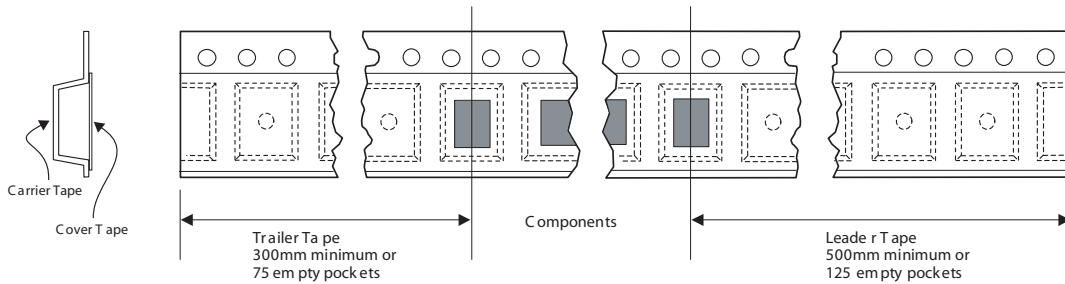

SOT-23 Std Tape and Reel Data, continued

SOT23-3L Embossed Carrier Tape Configuration: Figure 3.0

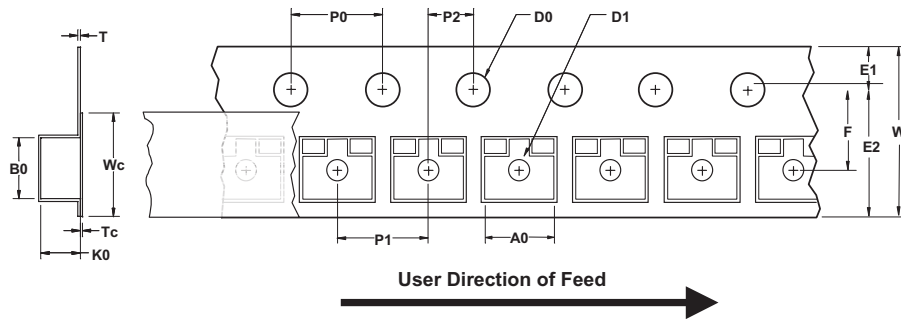

Dimensions are in millimeter

Pkg type	A0	B0	W	D0	D1	E1	E2	F	P1	P0	K0	T	Wc	Tc
SOT-23 (8mm)	3.15 +/-0.10	2.77 +/-0.10	8.0 +/-0.3	1.55 +/-0.05	1.125 +/-0.125	1.75 +/-0.10	6.25 min	3.50 +/-0.05	4.0 +/-0.1	4.0 +/-0.1	1.30 +/-0.10	0.228 +/-0.013	5.2 +/-0.3	0.06 +/-0.02

Notes: A0, B0, and K0 dimensions are determined with respect to the EIA/Jedec RS-481 rotational and lateral movement requirements (see sketches A, B, and C).

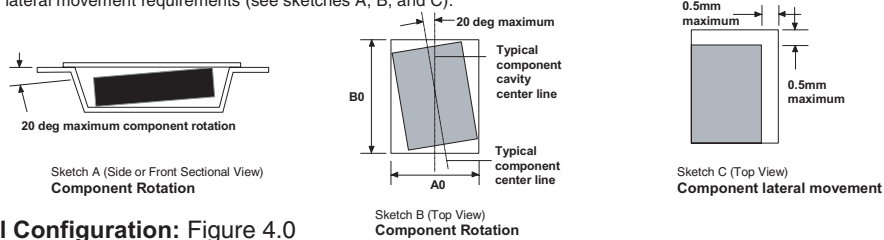

SOT23-3L Reel Configuration: Figure 4.0

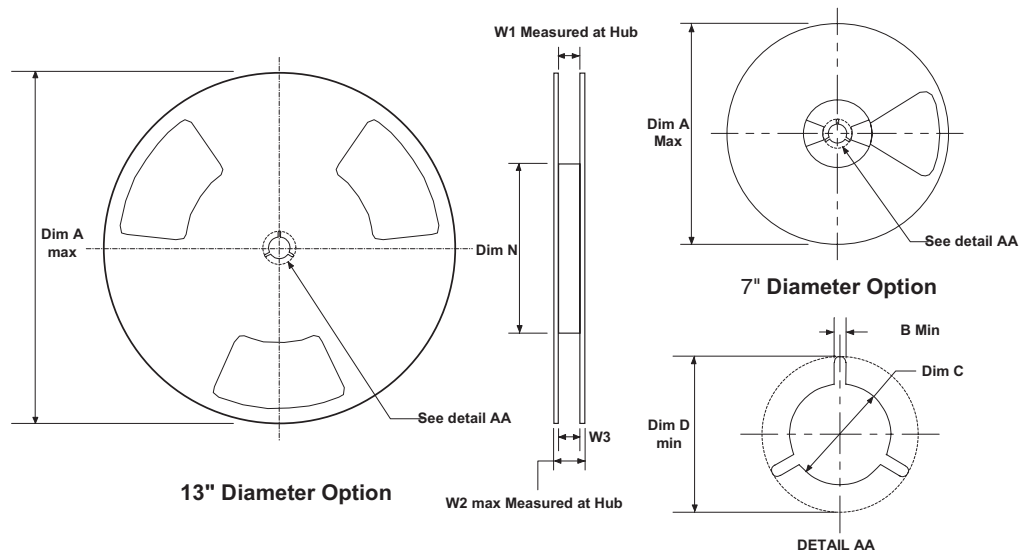

Dimensions are in inches and millimeters

Tape Size	Reel Option	Dim A	Dim B	Dim C	Dim D	Dim N	Dim W1	Dim W2	Dim W3 (LSL-USL)
8mm	7" Dia	7.00 177.8	0.059 1.5	512 +0.020/-0.008 13 +0.5/-0.2	0.795 20.2	2.165 55	0.331 +0.059/-0.000 8.4 +1.5/0	0.567 14.4	0.311 - 0.429 7.9 - 10.9
8mm	13" Dia	13.00 330	0.059 1.5	512 +0.020/-0.008 13 +0.5/-0.2	0.795 20.2	4.00 100	0.331 +0.059/-0.000 8.4 +1.5/0	0.567 14.4	0.311 - 0.429 7.9 - 10.9

Mechanical Dimensions (SOT-23)

SOT-23

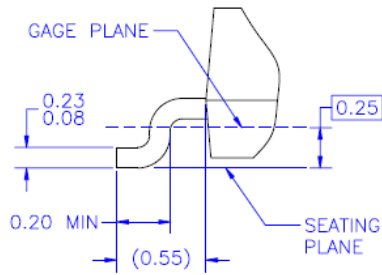
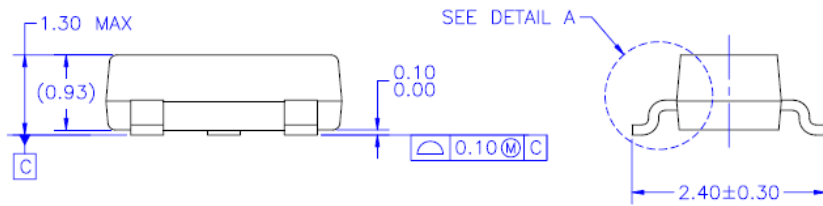
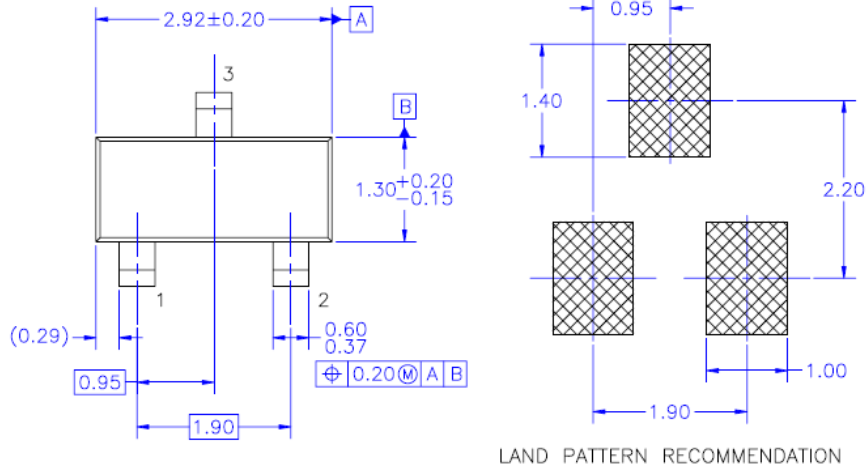

DETAIL A
SCALE: 2X

NOTES: UNLESS OTHERWISE SPECIFIED

- A) REFERENCE JEDEC REGISTRATION TO-236, VARIATION AB, ISSUE H.
- B) ALL DIMENSIONS ARE IN MILLIMETERS.
- C) DIMENSIONS ARE INCLUSIVE OF BURRS, MOLD FLASH AND TIE BAR EXTRUSIONS.
- D) DIMENSIONING AND TOLERANCING PER ASME Y14.5M — 1994.
- E) DRAWING FILE NAME: MA03DREV9

Dimensions in Millimeters

ON Semiconductor and  are trademarks of Semiconductor Components Industries, LLC dba ON Semiconductor or its subsidiaries in the United States and/or other countries. ON Semiconductor owns the rights to a number of patents, trademarks, copyrights, trade secrets, and other intellectual property. A listing of ON Semiconductor's product/patent coverage may be accessed at www.onsemi.com/site/pdf/Patent-Marking.pdf. ON Semiconductor reserves the right to make changes without further notice to any products herein. ON Semiconductor makes no warranty, representation or guarantee regarding the suitability of its products for any particular purpose, nor does ON Semiconductor assume any liability arising out of the application or use of any product or circuit, and specifically disclaims any and all liability, including without limitation special, consequential or incidental damages. Buyer is responsible for its products and applications using ON Semiconductor products, including compliance with all laws, regulations and safety requirements or standards, regardless of any support or applications information provided by ON Semiconductor. "Typical" parameters which may be provided in ON Semiconductor data sheets and/or specifications can and do vary in different applications and actual performance may vary over time. All operating parameters, including "Typicals" must be validated for each customer application by customer's technical experts. ON Semiconductor does not convey any license under its patent rights nor the rights of others. ON Semiconductor products are not designed, intended, or authorized for use as a critical component in life support systems or any FDA Class 3 medical devices or medical devices with a same or similar classification in a foreign jurisdiction or any devices intended for implantation in the human body. Should Buyer purchase or use ON Semiconductor products for any such unintended or unauthorized application, Buyer shall indemnify and hold ON Semiconductor and its officers, employees, subsidiaries, affiliates, and distributors harmless against all claims, costs, damages, and expenses, and reasonable attorney fees arising out of, directly or indirectly, any claim of personal injury or death associated with such unintended or unauthorized use, even if such claim alleges that ON Semiconductor was negligent regarding the design or manufacture of the part. ON Semiconductor is an Equal Opportunity/Affirmative Action Employer. This literature is subject to all applicable copyright laws and is not for resale in any manner.

PUBLICATION ORDERING INFORMATION

LITERATURE FULFILLMENT:

Literature Distribution Center for ON Semiconductor
19521 E. 32nd Pkwy, Aurora, Colorado 80011 USA
Phone: 303-675-2175 or 800-344-3860 Toll Free USA/Canada
Fax: 303-675-2176 or 800-344-3867 Toll Free USA/Canada
Email: orderlit@onsemi.com

N. American Technical Support: 800-282-9855 Toll Free
USA/Canada
Europe, Middle East and Africa Technical Support:
Phone: 421 33 790 2910
Japan Customer Focus Center
Phone: 81-3-5817-1050

ON Semiconductor Website: www.onsemi.com
Order Literature: <http://www.onsemi.com/orderlit>
For additional information, please contact your local
Sales Representative

Mouser Electronics

Authorized Distributor

Click to View Pricing, Inventory, Delivery & Lifecycle Information:

[ON Semiconductor:](#)

[MMBF170](#)